



- ▶ Industrial "All-In-One" - Standalone Panel PC
- ▶ Fanless solution
- ▶ True-flat front panel - Multitouch PCAP touch screen
- ▶ Protection IP65 & Impact resistant IK08 on front
- ▶ LED display 18.5" Wide 16:9 - Resolution Full HD 1920x1080
- ▶ Available in different versions of Intel® processor
- ▶ Cable cover with retaining joint
- ▶ Internal power supply **AC** or **DC** type
- ▶ Standard warranty 5 years parts and labor back workshop

### Key points

- ▶ **Standalone** Panel PC
- ▶ **Option box** in the handle
- ▶ **IP65 & IK08** on front panel
- ▶ **Internal** power supply

### Mechanical dimension

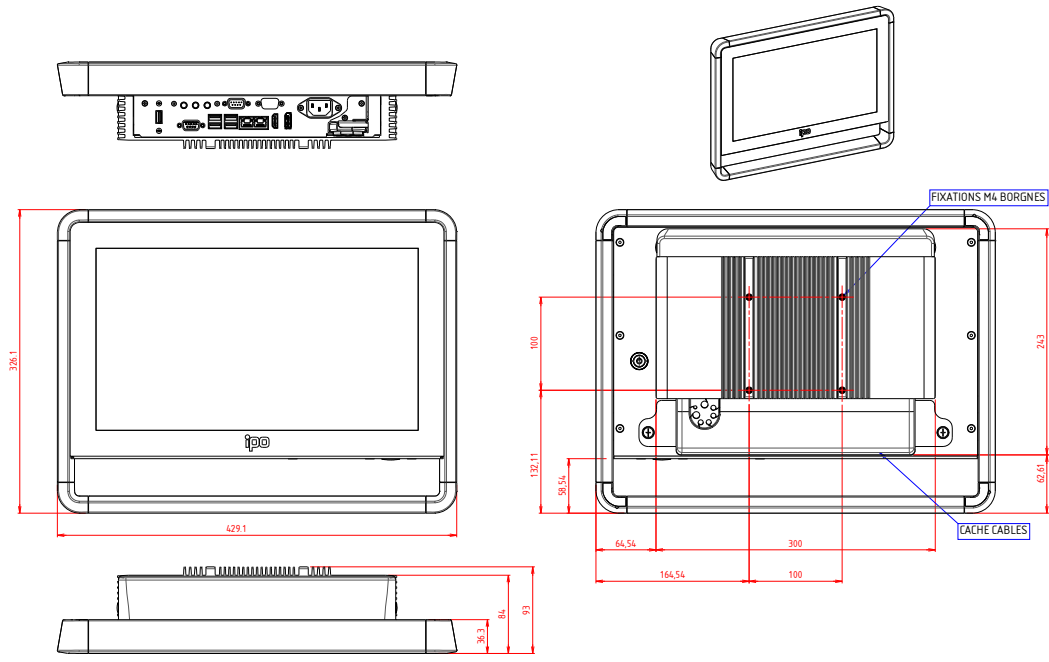













### Ordering Information









**FUTURA15WQPA-CV-\*\*\*** Industrial rugged Fanless True-flat Panel PC - Standalone with handle - IP65 & IK08 front panel - 18.5" Full HD - Intel® Pentium® QC N4200 - PCAP touch screen - Choose power supply

**FUTURA15WCIC-CV-\*\*\*** Industrial rugged Fanless True-flat Panel PC - Standalone with handle - IP65 & IK08 front panel - 18.5" Full HD - Intel® Core™ i5-1145G7E - PCAP touch screen - Choose power supply

**\*\* : Choose your internal power supply type : AC 230VAC or DC 9-36VDC**

 System		 System	
<b>Product name</b>	<b>FUTURA-15WQP</b>	<b>Product name</b>	<b>FUTURA-15WCIC</b>
<b>CPU Intel®</b>	Pentium® N4200 Quad Core (1.1/2.5GHz) – TPM (2.0)	<b>CPU Intel®</b>	Core™ i5-1145G7E (1.5GHz/4.1GHz) – TPM (2.0)
<b>Memory</b>	2 x DDR3L-1866 SO-DIMM (max. 8 Gb)	<b>Memory</b>	2 x DDR4-3200 SO-DIMM (max. 64Go)
<b>HDD / SSD</b>	1 x 2 1/2 SATA + 1 x mSATA + 1 x M.2 (B-key)	<b>HDD / SSD</b>	1 x 2 1/2 SATA + 3 x M.2 sockets (B-Key/E-Key/M-Key)
<b>Operating system</b>	Win 10 IoT Enterprise – Win 10 PRO – Win 11 PRO Compatible Linux on demand	<b>Operating system</b>	Win 10 IoT Enterprise – Win 10 PRO – Win 11 PRO Linux on demand
<b>I/O Ports</b>	4 x USB 3.0 – 1 x USB 2.0 2 x RS232 2 x Gigabit Ethernet (RJ45) 1 x Display port – 1 x HDMI – 1 x Bloc audio	<b>I/O Ports</b>	3 x USB 3.1 – 2 x USB 2.0 2 x RS232 2 x Gigabit Ethernet (RJ45) 2 x Display port – 1 x Bloc audio
 Construction Material		 Display	
<b>Chassis</b>	Treated aluminum case – 2mm thick	<b>Size/Type</b>	15.6" Wide – LED
<b>Frame</b>	Anodized aluminum profile – 1.5mm thick	<b>Display area</b>	344 x 193 mm
<b>Coin</b>	Polycarbonate – black standard – customizable	<b>Resolution max.</b>	1366 x 768 HD
<b>Front panel</b>	Trueflat + Front touch panel – 2.8mm thick	<b>LCD Color</b>	16.2 millions
<b>Color</b>	RAL9005 black textured paint rear chassis	<b>Pixel Pitch</b>	0.252 mm
<b>Mounting</b>	VESA 100 integrated into the heatsink	<b>Brightness</b>	500 cd/m²
<b>I/O cover</b>	With passage joint – cable retention	<b>Contrast Ratio</b>	500:1
<b>Speaker</b>	1 x 3W	<b>Viewing Angle max.</b>	Horizontal : 170° – Vertical : 160°
 Protection		 Touch screen	
<b>IP level</b>	IP65 compliant front panel	<b>Technology</b>	10-point Projected capacitive touch window
<b>Shock</b>	Impact resistance IK08	<b>Resistance</b>	6H
 Button & Indicator		 Industrial power supply	
<b>Rear panel</b>	On/Off switch button with LED backlight Brightness adjustment by software application (for Windows)	<b>Version AC~</b>	Input: 115/230VAC – Frequency: 50/60Hz
		<b>Version DC</b>	Wide range: 9-36VDC Reverse polarity protection – Galvanic isolation
		<b>Power Consumption max</b>	Version QP: 75W – Version CI: 80W
 Environment		 Safety and EMC	
<b>Operating Temperature</b>	0° ~ + 45°C (QPA) – 0° ~ + 40°C (CIC)	<b>Safety</b>	EN 62368-1
<b>Storage Temperature</b>	- 20 ..... + 60°C	<b>EMC</b>	EN 55032 / EN 55024 EN 61000-3-2 / EN 61000-3-3
<b>Relative Humidity</b>	5 ..... 95 %		
 Cooling system		 Dimensions	
<b>Type</b>	Fanless Natural convection cooling	<b>Dimensions ((WxLxD)</b>	429.1 x 326.1 x 93 mm
		<b>Weight (Net) – kg</b>	5.5

## Options & Accessories

	<b>ZFUT-PT</b>	VESA table stand		<b>ZFUT-SUP-CLAV</b>	Keyboard Support
	<b>ZFUT-BT</b>	Arm mounting table solution		<b>FUT-SUP-DOUCH</b>	Bar code reader support
	<b>ZFUT-BM</b>	Arm mounting wall solution		<b>ZFUT-ARGOS</b>	Adjustable desk support
	<b>PIED-TUBE-L1400</b>	Floor Tube Foot Support – Square format – Height: 1400mm		<b>ZFUT-WIFI-2-A</b>	Solution Wifi + Bluetooth
				<b>FUT-WIFI-BT-CIC</b>	Solution Wifi6 +Bluetooth Version CI
	<b>Option box:</b> in the frame under the machine Output on front or rear face – different sizes allowing custom integration: RFID reader, Emergency stop, Function keys, USB, RS-232, Lan, ...				

## Packing list

1 x Power cord CE22 1.80 m (AC~ version)

1 x Software Licence (label format)

1 x Production&Traceability datasheet