



- ▶ Industrial "All-In-One" - Standalone Panel PC
- ▶ Fanless solution
- ▶ True-flat front panel - Multitouch PCAP touch screen
- ▶ Protection IP65 & Impact resistant IK08 on front
- ▶ LED display 21.5" Wide 16:9 - Resolution Full HD 1920x1080
- ▶ Available in different versions of Intel® processor
- ▶ Cable cover with retaining joint
- ▶ Internal power supply AC or DC type
- ▶ Standard warranty 5 years parts and labor back workshop

### Key points

- ▶ **Standalone** Panel PC
- ▶ **Option box** in the handle
- ▶ **IP65 & IK08** on front panel
- ▶ **Internal** power supply

### Mechanical dimension

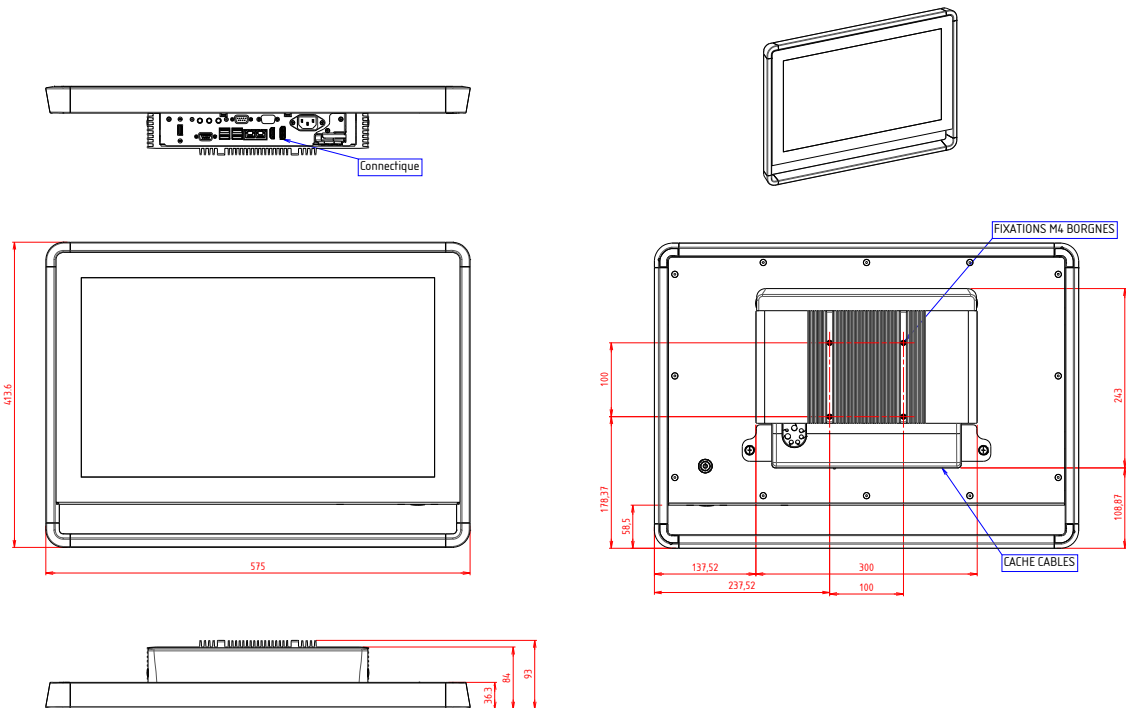











### Ordering Information











**FUTURA21WQPA-CV-\*\*\*** Industrial rugged Fanless True-flat Panel PC - Standalone with handle - IP65 & IK08 front panel - 21.5" Full HD - Intel® Pentium® QC N4200 - PCAP touch screen - Choose power supply

**FUTURA21WCIB-CV-\*\*\*** Industrial rugged Fanless True-flat Panel PC - Standalone with handle - IP65 & IK08 front panel - 21.5" Full HD - Intel® Core™ i5-7300U - PCAP touch screen - Choose power supply

**\*\* : Choose your internal power supply type : AC 230VAC or DC 9-36VDC**

 System	
<b>Product name</b>	<b>FUTURA-18WQP</b>
<b>CPU Intel®</b>	Pentium® N4200 Quad Core (1.1/2.5GHz) – TPM (2.0)
<b>Memory</b>	2 x DDR3L-1866 SO-DIMM (max. 8 Gb)
<b>HDD / SSD</b>	1 x 2”1/2 SATA + 1 x mSATA + 1 x M.2 (B-key)
<b>Operating system</b>	Win 10 IoT Enterprise – Win 10 PRO – Win 11 PRO Linux on demand
<b>I/O Ports</b>	4 x USB 3.0 – 1 x USB 2.0 2 x RS232 2 x Gigabit Ethernet (RJ45) 1 x Display port – 1 x HDMI – 1 x Bloc audio
	<b>Construction Material</b>
<b>Chassis</b>	Treated aluminum case – 2mm thick
<b>Frame</b>	Anodized aluminum profile – 1.5mm thick
<b>Coin</b>	Polycarbonate – black standard – customizable
<b>Front panel</b>	Trueflat + Front touch panel – 2.8mm thick
<b>Color</b>	RAL9005 black textured paint rear chassis
<b>Mounting</b>	VESA 100 integrated into the heatsink
<b>I/O cover</b>	With passage joint – cable retention
<b>Speaker</b>	1 x 3W
	<b>Protection</b>
<b>IP level</b>	IP65 compliant front panel
<b>Shock</b>	Impact resistance IK08
	<b>Button &amp; Indicator</b>
<b>Rear panel</b>	On/Off switch button with LED backlight Brightness adjustment by software application (for Windows)
	<b>Environment</b>
<b>Operating Temperature</b>	0° ~ + 45°C
<b>Storage Temperature</b>	- 20 .... + 60°C
<b>Relative Humidity</b>	5 ..... 95 %
	<b>Cooling system</b>
<b>Type</b>	Fanless Natural convection cooling
	<b>Display</b>
<b>Size/Type</b>	18.5” Wide – LED
<b>Display area</b>	408.96 x 230.04 mm
<b>Resolution max.</b>	1920 x 1080 Full HD
<b>LCD Color</b>	16.7 millions
<b>Pixel Pitch</b>	0.213 mm
<b>Brightness</b>	350 cd/m²
<b>Contrast Ratio</b>	1000:1
<b>Viewing Angle max.</b>	Horizontal : 178° – Vertical : 178°
	<b>Touch screen</b>
<b>Technology</b>	10-point Projected capacitive touch window
<b>Résistance</b>	6H
	<b>Industrial power supply</b>
<b>Version AC~</b>	Input: 115/230VAC – Frequency: 50/60Hz
<b>Version DC</b>	Wide range: 9–36VDC Reverse polarity protection – Galvanic isolation
<b>Power Consumption max</b>	Version QP: 85W – Version CI: 100W
	<b>Safety and EMC</b>
<b>Safety</b>	EN 62368-1
<b>EMC</b>	EN 55032 / EN 55024 EN 61000-3-2 / EN 61000-3-3
	<b>Dimensions</b>
<b>Dimensions ((WxLxD)</b>	575 x 413.6 x 93 mm
<b>Weight (Net) – kg</b>	8.5

## Options & Accessories

	<b>ZFUT-PT</b>	VESA table stand		<b>ZFUT-SUP-CLAV</b>	Keyboard Support
	<b>ZFUT-BT</b>	Arm mouting table solution		<b>FUT-SUP-DOUCH</b>	Bar code reader support
	<b>ZFUT-BM</b>	Arm mouting wall solution		<b>ZFUT-ARGOS</b>	Adjustable desk support
	<b>PIED-TUBE-L1400</b>	Floor Tube Foot Support – Square format – Height: 1400mm		<b>ZFUT-WIFI-A</b>	Solution Wifi + Bluetooth
	<b>Option box:</b> in the frame under the machine Output on front or rear face – different sizes allowing custom integration: RFID reader, Emergency stop, Function keys, USB, RS-232, Lan, ...				

## Packing list

1 x Power cord CE22 1.80 m (AC~ version)

1 x Software Licence (label format)

1 x Production&Traceability datasheet