

-
-
-
-
-
-
-
-



- ▶ Industrial "All-In-One" - Standalone Panel PC
- ▶ Fanless solution
- ▶ True-flat font panel - Multitouch PCAP touch screen
- ▶ Protection IP65 & Impact resistant IK08 on front
- ▶ LED display 18.5" Wide 16:9 - Resolution Full HD 1920x1080
- ▶ Available in different versions of Intel® processor
- ▶ Cable cover with retaining joint
- ▶ Internal power supply AC or DC type
- ▶ Standard warranty 5 years parts and labor back workshop

Key points

- ▶ **Standalone** Panel PC
- ▶ **Option box** in the handle
- ▶ **IP65 & IK08** on front panel
- ▶ **Internal** power supply

Mechanical dimension

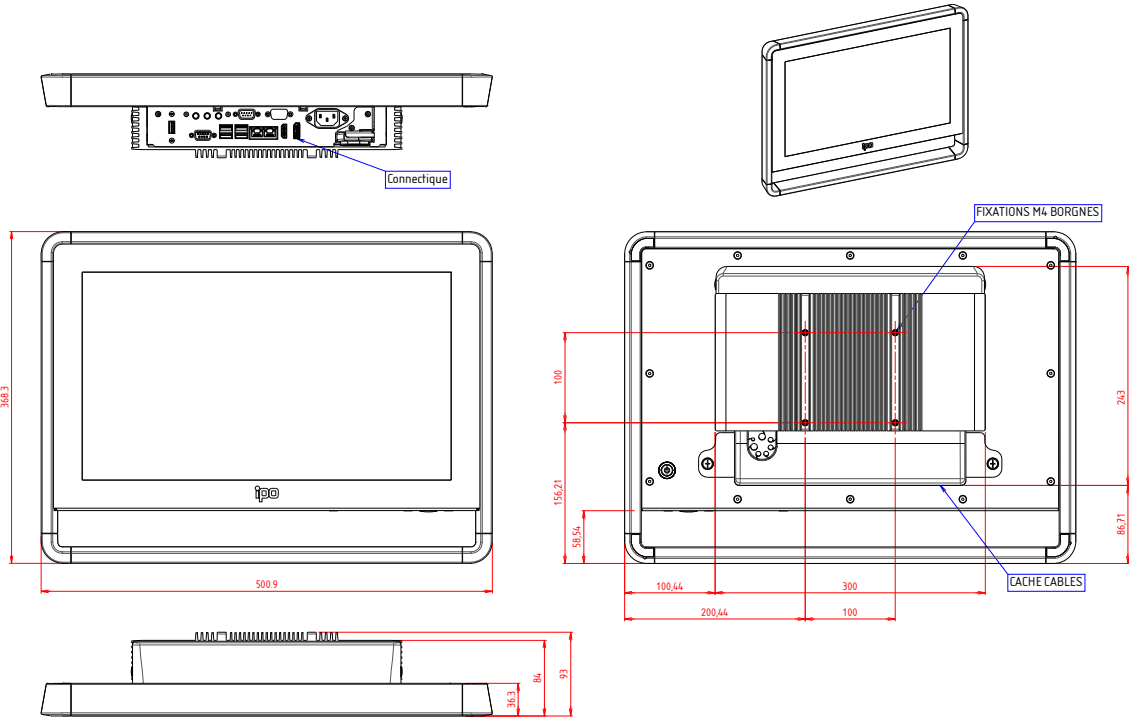











Ordering Information











FUTURA18WQPA-CV-*** Industrial rugged Fanless True-flat Panel PC - Standalone with handle - IP65 & IK08 front panel - 18.5" Full HD - Intel® Pentium® QC N4200 - PCAP touch screen - Choose power supply

FUTURA18WCIB-CV-*** Industrial rugged Fanless True-flat Panel PC - Standalone with handle - IP65 & IK08 front panel - 18.5" Full HD - Intel® Core™ i5-7300U - PCAP touch screen - Choose power supply

**** : Choose your internal power supply type : AC 230VAC or DC 9-36VDC**

 System	
Product name	FUTURA-18WQP
CPU Intel®	Pentium® N4200 Quad Core (1.1/2.5GHz) – TPM (2.0)
Memory	2 x DDR3L-1866 SO-DIMM (max. 8 Gb)
HDD / SSD	1 x 2 1/2 SATA + 1 x mSATA + 1 x M.2 (B-key)
Operating system	Win 10 IoT Enterprise – Win 10 PRO – Win 11 PRO Linux on demand
I/O Ports	4 x USB 3.0 – 1 x USB 2.0 2 x RS232 2 x Gigabit Ethernet (RJ45) 1 x Display port – 1 x HDMI – 1 x Bloc audio
	Construction Material
Chassis	Treated aluminum case – 2mm thick
Frame	Anodized aluminum profile – 1.5mm thick
Coin	Polycarbonate – black standard – customizable
Front panel	Trueflat + Front touch panel – 2.8mm thick
Color	RAL9005 black textured paint rear chassis
Mounting	VESA 100 integrated into the heatsink
I/O cover	With passage joint – cable retention
Speaker	1 x 3W
	Protection
IP level	IP65 compliant front panel
Shock	Impact resistance IK08
	Button & Indicator
Rear panel	On/Off switch button with LED backlight Brightness adjustment by software application (for Windows)
	Environment
Operating Temperature	0° ~ + 45°C
Storage Temperature	- 20 + 60°C
Relative Humidity	5 95 %
	Cooling system
Type	Fanless Natural convection cooling
	Display
Size/Type	18.5" Wide – LED
Display area	408.96 x 230.04 mm
Resolution max.	1920 x 1080 Full HD
LCD Color	16.7 millions
Pixel Pitch	0.213 mm
Brightness	350 cd/m²
Contrast Ratio	1000:1
Viewing Angle max.	Horizontal : 178° – Vertical : 178°
	Touch screen
Technology	10-point Projected capacitive touch window
Résistance	6H
	Industrial power supply
Version AC~	Input: 115/230VAC – Frequency: 50/60Hz
Version DC	Wide range: 9–36VDC Reverse polarity protection – Galvanic isolation
Power Consumption max	Version QP: 85W – Version CI: 100W
	Safety and EMC
Safety	EN 62368-1
EMC	EN 55032 / EN 55024 EN 61000-3-2 / EN 61000-3-3
	Dimensions
Dimensions ((WxLxD)	500.9 x 368.3 x 93 mm
Weight (Net) – kg	7

Options & Accessories

	ZFUT-PT	VESA table stand		ZFUT-SUP-CLAV	Keyboard Support
	ZFUT-BT	Arm mounting table solution		FUT-SUP-DOUCH	Bar code reader support
	ZFUT-BM	Arm mounting wall solution		ZFUT-ARGOS	Adjustable desk support
	PIED-TUBE-L1400	Floor Tube Foot Support – Square format – Height: 1400mm		ZFUT-WIFI-A	Solution Wifi + Bluetooth
	Option box: in the frame under the machine Output on front or rear face – different sizes allowing custom integration: RFID reader, Emergency stop, Function keys, USB, RS-232, Lan, ...				

Packing list

1 x Power cord CE22 1.80 m (AC~ version)

1 x Software Licence (label format)

1 x Production&Traceability datasheet